



向心关节轴承 Radial Spherical Plain Bearings



滑动摩擦副：钢 / 钢

Sliding contact surfaces: Steel / Steel

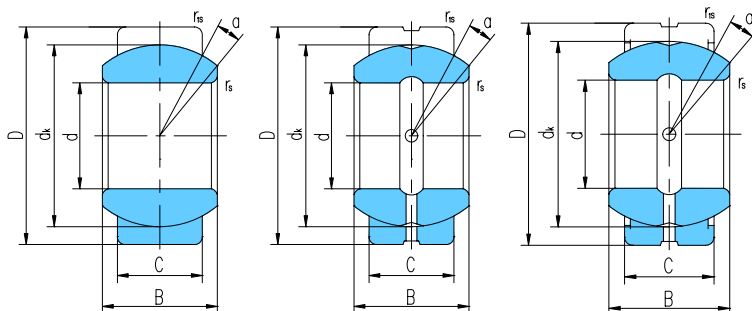

GE...E

GE...ES

GE...ES-2RS

轴承 型号 Bearing number	外形尺寸 Dimensions								额定载荷 Load ratings		重量 Weight ≈kg	
	mm								kN			
	d	D	B	C	dk	rs min	rs min	α° ≈	动载荷 Dynamic	静载荷 Static		
GE4E		4	12	5	3	8	0.3	0.3	16	2	10	0.003
GE5E		5	14	6	4	10	0.3	0.3	13	3.4	17	0.005
GE6E		6	14	6	4	10	0.3	0.3	13	3.4	17	0.004
GE8E		8	16	8	5	13	0.3	0.3	15	5.5	27	0.007
GE10E		10	19	9	6	16	0.3	0.3	12	8.1	40	0.011
GE12E		12	22	10	7	18	0.3	0.3	10	10	53	0.017
GE15ES	GE15ES-2RS	15	26	12	9	22	0.3	0.3	8	16	84	0.026
GE17ES	GE17ES-2RS	17	30	14	10	25	0.3	0.3	10	21	106	0.040
GE20ES	GE20ES-2RS	20	35	16	12	29	0.3	0.3	9	30	146	0.064
GE25ES	GE25ES-2RS	25	42	20	16	35.5	0.6	0.6	7	48	240	0.115
GE30ES	GE30ES-2RS	30	47	22	18	40.7	0.6	0.6	6	62	310	0.149
GE35ES	GE35ES-2RS	35	55	25	20	47	0.6	1	6	79	399	0.228
GE40ES	GE40ES-2RS	40	62	28	22	53	0.6	1	7	99	495	0.318
GE45ES	GE45ES-2RS	45	68	32	25	60	0.6	1	7	127	637	0.421
GE50ES	GE50ES-2RS	50	75	35	28	66	0.6	1	6	156	780	0.562
GE55ES	GE55ES-2RS	55	85	40	32	74	0.6	1	7	200	1000	0.864
GE60ES	GE60ES-2RS	60	90	44	36	80	1	1	6	245	1220	1.03
GE70ES	GE70ES-2RS	70	105	49	40	92	1	1	6	313	1560	1.57
GE80ES	GE80ES-2RS	80	120	55	45	105	1	1	6	400	2000	2.32
GE90ES	GE90ES-2RS	90	130	60	50	115	1	1	5	488	2440	2.79
GE100ES	GE100ES-2RS	100	150	70	55	130	1	1	7	607	3030	4.44
GE110ES	GE110ES-2RS	110	160	70	55	140	1	1	6	654	3270	4.83
GE120ES	GE120ES-2RS	120	180	85	70	160	1	1	6	950	4750	8.11
GE140ES	GE140ES-2RS	140	210	90	70	180	1	1	7	1070	5350	11.2
GE160ES	GE160ES-2RS	160	230	105	80	200	1	1	8	1360	6800	14.1
GE180ES	GE180ES-2RS	180	260	105	80	225	1.1	1.1	6	1530	7650	18.5
GE200ES	GE200ES-2RS	200	290	130	100	250	1.1	1.1	7	2120	10600	28.4
GE220ES	GE220ES-2RS	220	320	135	100	275	1.1	1.1	8	2320	11600	35.7
GE240ES	GE240ES-2RS	240	340	140	100	300	1.1	1.1	8	2550	12700	39.7
GE260ES	GE260ES-2RS	260	370	150	110	325	1.1	1.1	7	3030	15190	51.5
GE280ES	GE280ES-2RS	280	400	155	120	350	1.1	1.1	6	3570	17850	64.9
GE300ES	GE300ES-2RS	300	430	165	120	375	1.1	1.1	7	3800	19100	77.6

内径 $\phi 50 \leq d \leq \phi 200\text{mm}$ 外圈内球面可设计交叉润滑槽，图示见 P112 图 1，轴承型号需加 “/J”，例如：

GE80ES/J

$\phi 50 \leq d \leq \phi 200\text{mm}$, the sliding surface of outer ring can be designed crossed grooves, sketch map see page P112 figure1, suffix “/J” is added to bearing number, e.g. GE80ES/J



向心关节轴承 Radial Spherical Plain Bearings

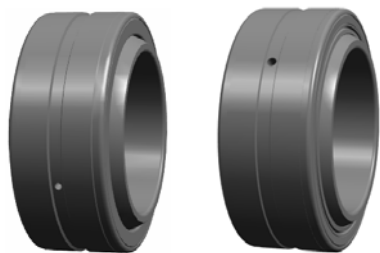

滑动摩擦副：钢 / 钢

Sliding contact surfaces: Steel / Steel

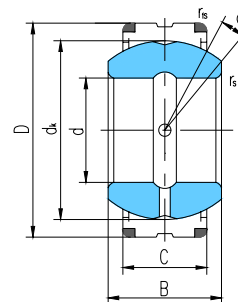
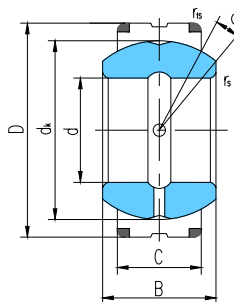

GEC...XS

GEC...XS-2RS

轴承型号 Bearing number		外形尺寸 Dimensions								额定载荷 Load ratings		重量 Weight ≈kg
		mm								kN		
		d	D	B	C	dk	rs min	r1s min	α° ≈	动载荷 Dynamic	静载荷 Static	
GEC320XS	GEC320XS-2RS	320	440	160	135	380	1.1	3	4	4400	22000	78
GEC340XS	GEC340XS-2RS	340	460	160	135	400	1.1	3	3	4650	23200	83
GEC360XS	GEC360XS-2RS	360	480	160	135	420	1.1	3	3	4800	24000	87
GEC380XS	GEC380XS-2RS	380	520	190	160	450	1.5	4	4	6300	31500	129
GEC400XS	GEC400XS-2RS	400	540	190	160	470	1.5	4	3	6550	32500	135
GEC420XS	GEC420XS-2RS	420	560	190	160	490	1.5	4	3	6800	34500	141
GEC440XS	GEC440XS-2RS	440	600	218	185	520	1.5	4	3	8650	42300	196
GEC460XS	GEC460XS-2RS	460	620	218	185	540	1.5	4	3	9000	45000	204



向心关节轴承 Radial Spherical Plain Bearings



滑动摩擦副：钢 / 钢

Sliding contact surfaces: Steel / Steel

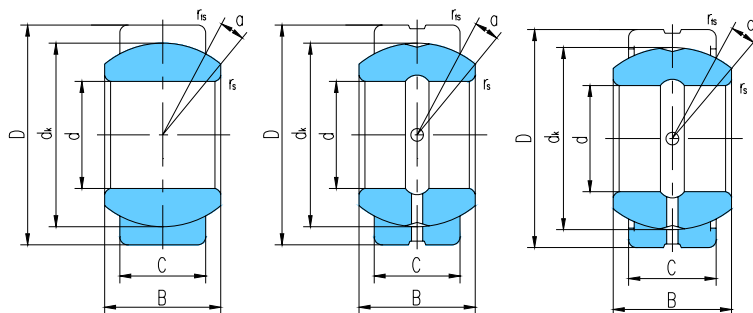

GEG...E

GEG...ES

GEG...ES-2RS

轴承 型号 Bearing number	外形尺寸 Dimensions mm									额定载荷 Load ratings kN		重量 Weight ≈kg
	d	D	B	C	d _k	r _s min	r _{1s} min	α° ≈	动载荷 Dynamic	静载荷 Static		
GEG4E		4	14	7	4	10	0.3	0.3	20	3.4	17	0.005
GEG5E		5	16	9	5	13	0.3	0.3	21	5.5	27	0.009
GEG6E		6	16	9	5	13	0.3	0.3	21	5.5	27	0.008
GEG8E		8	19	11	6	16	0.3	0.3	21	8.1	40	0.014
GEG10E		10	22	12	7	18	0.3	0.3	18	10	53	0.021
GEG12E		12	26	15	9	22	0.3	0.3	18	16	84	0.036
GEG15ES	GEG15ES-2RS	15	30	16	10	25	0.3	0.3	16	21	106	0.048
GEG17ES	GEG17ES-2RS	17	35	20	12	29	0.3	0.3	19	30	146	0.080
GEG20ES	GEG20ES-2RS	20	42	25	16	35.5	0.3	0.6	17	48	240	0.152
GEG25ES	GEG25ES-2RS	25	47	28	18	40.7	0.6	0.6	17	62	310	0.199
GEG30ES	GEG30ES-2RS	30	55	32	20	47	0.6	1	17	79	399	0.296
GEG35ES	GEG35ES-2RS	35	62	35	22	53	0.6	1	16	99	495	0.402
GEG40ES	GEG40ES-2RS	40	68	40	25	60	0.6	1	17	127	637	0.535
GEG45ES	GEG45ES-2RS	45	75	43	28	66	0.6	1	15	156	780	0.698
GEG50ES	GEG50ES-2RS	50	90	56	36	80	0.6	1	17	245	1220	1.42
GEG60ES	GEG60ES-2RS	60	105	63	40	92	1	1	17	313	1560	2.09
GEG70ES	GEG70ES-2RS	70	120	70	45	105	1	1	16	400	2000	3.01
GEG80ES	GEG80ES-2RS	80	130	75	50	115	1	1	14	488	2440	3.61
GEG90ES	GEG90ES-2RS	90	150	85	55	130	1	1	15	607	3030	5.50
GEG100ES	GEG100ES-2RS	100	160	85	55	140	1	1	14	654	3270	6.04
GEG110ES	GEG110ES-2RS	110	180	100	70	160	1	1	12	950	4750	9.74
GEG120ES	GEG120ES-2RS	120	210	115	70	180	1	1	16	1070	5350	15.1
GEG140ES	GEG140ES-2RS	140	230	130	80	200	1	1	16	1360	6800	18.9
GEG160ES	GEG160ES-2RS	160	260	135	80	225	1.1	1.1	16	1530	7650	24.8
GEG180ES	GEG180ES-2RS	180	290	155	100	250	1.1	1.1	14	2120	10600	35.9
GEG200ES	GEG200ES-2RS	200	320	165	100	275	1.1	1.1	15	2320	11600	44.9
GEG220ES	GEG220ES-2RS	220	340	175	100	300	1.1	1.1	16	2550	12700	50.9
GEG240ES	GEG240ES-2RS	240	370	190	110	325	1.1	1.1	15	3030	15190	65.3
GEG260ES	GEG260ES-2RS	260	400	205	120	350	1.1	1.1	15	3570	17850	82.0
GEG280ES	GEG280ES-2RS	280	430	210	120	375	1.1	1.1	15	3800	19100	96.6



向心关节轴承 Radial Spherical Plain Bearings



滑动摩擦副：钢 / 钢

Sliding contact surfaces: Steel / Steel

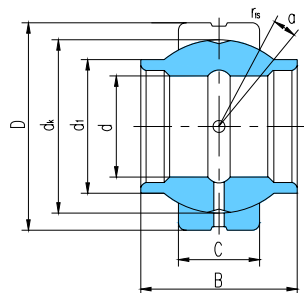

轴承 型号 Bearing number	外形尺寸 Dimensions									额定载荷 Load ratings		重量 Weight ≈ kg
	d	D	B	C	d _i max	d _k	r _s min	r _{1s} min	α° ≈	动载荷 Dynamic	静载荷 Static	
GEEW12ES*	12	22	12	7	15.5	18	0.3	0.3	4	10	53	0.017
GEEW15ES	15	26	15	9	18.5	22	0.3	0.3	5	16	84	0.028
GEEW16ES	16	28	16	9	20	23	0.3	0.3	4	17	85	0.034
GEEW17ES	17	30	17	10	21	25	0.3	0.3	7	21	106	0.043
GEEW20ES	20	35	20	12	25	29	0.3	0.3	4	30	146	0.069
GEEW25ES	25	42	25	16	30.5	35.5	0.6	0.6	4	48	240	0.124
GEEW30ES	30	47	30	18	34	40.7	0.6	0.6	4	62	310	0.159
GEEW32ES	32	52	32	18	37	43	0.6	1	4	65	328	0.207
GEEW35ES	35	55	35	20	40	47	0.6	1	4	79	399	0.248
GEEW40ES	40	62	40	22	46	53	0.6	1	4	99	495	0.349
GEEW45ES	45	68	45	25	52	60	0.6	1	4	127	637	0.468
GEEW50ES	50	75	50	28	57	66	0.6	1	4	156	780	0.62
GEEW60ES	60	90	60	36	68	80	1	1	4	245	1220	1.11
GEEW63ES	63	95	63	36	71.5	83	1	1	4	253	1260	1.27
GEEW70ES	70	105	70	40	78	92	1	1	4	313	1560	1.69
GEEW80ES	80	120	80	45	91	105	1	1	4	400	2000	2.55
GEEW90ES	90	130	90	50	99	115	1	1	4	488	2440	3.04
GEEW100ES	100	150	100	55	113	130	1	1	4	607	3030	4.87
GEEW110ES	110	160	110	55	124	140	1	1	4	654	3270	5.53
GEEW125ES	125	180	125	70	138	160	1	1	4	950	4750	8.19
GEEW160ES	160	230	160	80	177	200	1	1	4	1360	6800	15.8
GEEW200ES	200	290	200	100	221	250	1.1	1.1	4	2120	10600	31.7
GEEW250ES	250	400	250	120	317	350	1.1	1.1	4	3750	17800	101
GEEW320ES	320	520	320	160	405	450	1.1	1.1	4	6200	30500	225

*仅外圈有润滑槽孔。A lubrication groove and holes in the outer ring only.

内径 $d \geq \phi 15\text{mm}$ ，可提供带密封圈的向心关节轴承。Can supply spherical plain bearing with two seals for bore diameter $d \geq \phi 15\text{mm}$.



向心关节轴承 Radial Spherical Plain Bearings



滑动摩擦副：钢 / 钢

Sliding contact surfaces: Steel / Steel

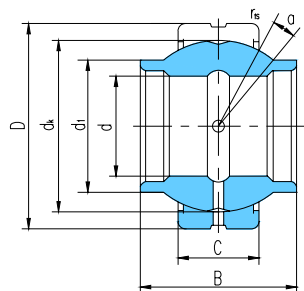

轴承 型号 Bearing number	外形尺寸 Dimensions									额定载荷 Load ratings		重量 Weight ≈kg
	mm									kN		
	d	D	B	C	d ₁ max	d _k	r _s min	r _{1s} min	α° ≈	动载荷 Dynamic	静载荷 Static	
GEEM20ES-2RS	20	35	24	12	24	29	0.3	0.3	6	30	146	0.072
GEEM25ES-2RS	25	42	29	16	29	35.5	0.3	0.6	4	48	240	0.13
GEEM30ES-2RS	30	47	30	18	34	40.7	0.3	0.6	4	62	310	0.16
GEEM35ES-2RS	35	55	35	20	40	47	0.6	1	4	79	399	0.25
GEEM40ES-2RS	40	62	38	22	45	53	0.6	1	4	99	495	0.34
GEEM45ES-2RS	45	68	40	25	52	60	0.6	1	4	127	637	0.45
GEEM50ES-2RS	50	75	43	28	57	66	0.6	1	4	156	780	0.59
GEEM60ES-2RS	60	90	54	36	68	80	0.6	1	3	245	1220	1.06
GEEM70ES-2RS	70	105	65	40	78	92	0.6	1	4	313	1560	1.66
GEEM80ES-2RS	80	120	74	45	90	105	0.6	1	4	400	2000	2.47
GEEM90ES-2RS	90	130	80	50	99	115	1	1	4	488	2440	2.88
GEEM100ES-2RS	100	150	90	55	113	130	1	1	4	607	3030	4.65
GEEM120ES-2RS	120	180	108	70	133	160	1	1	4	950	4750	8.44



向心关节轴承 Radial Spherical Plain Bearings



滑动摩擦副：钢 / 钢

Sliding contact surfaces: Steel / Steel

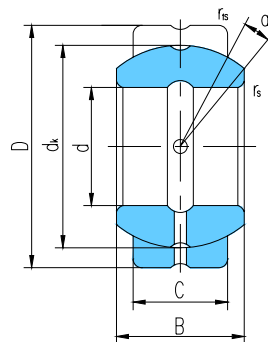

轴承 型号 Bearing number	外形尺寸 Dimensions								额定载荷 Load ratings		重量 Weight ≈kg
	d	D	B	C	dk	rs min	r1s min	α° ≈	动载荷 Dynamic	静载荷 Static	
GEF12ES	12	22	11	9	18	0.5	0.5	7	13	68	0.019
GEF15ES	15	26	13	11	22	0.5	0.5	6	20	102	0.031
GEF20ES	20	32	16	14	28	0.5	0.5	4	33	166	0.054
GEF22ES	22	37	19	16	32	0.5	0.5	6	43	217	0.088
GEF25ES	25	42	21	18	36	0.5	0.5	5	55	275	0.128
GEF30ES	30	50	27	23	45	1	1	6	87	439	0.232
GEF35ES	35	55	30	26	50	1	1	5	110	552	0.291
GEF40ES	40	62	33	28	55	1	1	6	130	654	0.392
GEF45ES	45	72	36	31	62	1	1	5	163	816	0.609
GEF50ES	50	80	42	36	72	1	1	5	220	1100	0.885
GEF55ES	55	90	47	40	80	1	1	6	272	1360	1.29
GEF60ES	60	100	53	45	90	1	1	6	344	1720	1.84
GEF65ES	65	105	55	47	94	1	1	5	375	1870	2.03
GEF70ES	70	110	58	50	100	1	1	5	425	2125	2.28
GEF75ES	75	120	64	55	110	1	1	5	510	2570	3.08
GEF80ES	80	130	70	60	120	1	1	5	610	3060	4.04
GEF85ES	85	135	74	63	125	1	1	6	669	3340	4.44
GEF90ES	90	140	76	65	130	1	1	5	718	3590	4.79
GEF95ES	95	150	82	70	140	1	1	5	833	4165	6.07
GEF100ES	100	160	88	75	150	1.5	1.5	5	956	4780	7.56
GEF110ES	110	170	93	80	160	1.5	1.5	5	1080	5440	8.63
GEF115ES	115	180	98	85	165	1.5	1.5	5	1190	5960	10.4
GEF120ES	120	190	105	90	175	1.5	1.5	6	1330	6690	12.5
GEF130ES	130	200	110	95	185	1.5	1.5	5	1490	7460	14.0
GEF150ES	150	220	120	105	205	1.5	1.5	5	1820	9140	17.2



向心关节轴承 Radial Spherical Plain Bearings



滑动摩擦副：钢 / 钢
Sliding contact surfaces: Steel / Steel

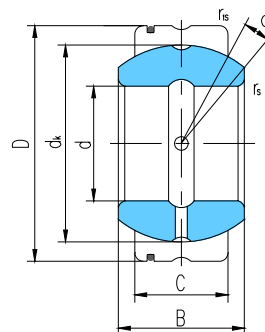

轴承 型号 Bearing number	外形尺寸 Dimensions mm								额定载荷 Load ratings kN		重量 Weight ≈kg
	d	D	B	C	dk	rs min	r1s min	α° ≈	动载荷 Dynamic	静载荷 Static	
GE12XS/K	12	22	11	9	18	0.5	0.5	7	13	68	0.019
GE15XS/K	15	26	13	11	22	0.5	0.5	6	20	102	0.031
GE20XS/K	20	32	16	14	28	0.5	0.5	4	33	166	0.054
GE22XS/K	22	37	19	16	32	0.5	0.5	6	43	217	0.088
GE25XS/K	25	42	21	18	36	0.5	0.5	5	55	275	0.128
GE30XS/K	30	50	27	23	45	1	1	6	87	439	0.232
GE35XS/K	35	55	30	26	50	1	1	5	110	552	0.291
GE40XS/K	40	62	33	28	55	1	1	6	130	654	0.392
GE45XS/K	45	72	36	31	62	1	1	5	163	816	0.609
GE50XS/K	50	80	42	36	72	1	1	5	220	1100	0.885
GE55XS/K	55	90	47	40	80	1	1	6	272	1360	1.29
GE60XS/K	60	100	53	45	90	1	1	6	344	1720	1.84
GE65XS/K	65	105	55	47	94	1	1	5	375	1870	2.03
GE70XS/K	70	110	58	50	100	1	1	5	425	2125	2.28
GE75XS/K	75	120	64	55	110	1	1	5	510	2570	3.08
GE80XS/K	80	130	70	60	120	1	1	5	610	3060	4.04
GE85XS/K	85	135	74	63	125	1	1	6	669	3340	4.44
GE90XS/K	90	140	76	65	130	1	1	5	718	3590	4.79
GE95XS/K	95	150	82	70	140	1	1	5	833	4165	6.07
GE100XS/K	100	160	88	75	150	1.5	1.5	5	956	4780	7.56
GE110XS/K	110	170	93	80	160	1.5	1.5	5	1080	5440	8.63
GE115XS/K	115	180	98	85	165	1.5	1.5	5	1190	5960	10.4
GE120XS/K	120	190	105	90	175	1.5	1.5	6	1330	6690	12.5
GE130XS/K	130	200	110	95	185	1.5	1.5	5	1490	7460	14.0
GE150XS/K	150	220	120	105	205	1.5	1.5	5	1820	9140	17.2



向心关节轴承 Radial Spherical Plain Bearings



滑动摩擦副：钢 / 钢

Sliding contact surfaces: Steel / Steel

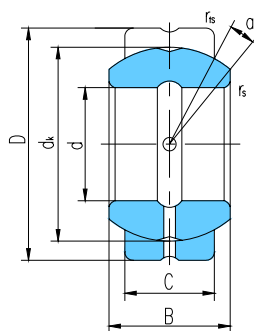

GEZ...ES

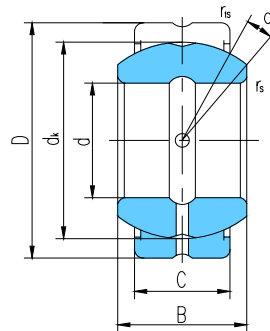

GEZ...ES-2RS

轴承型号 Bearing number	外形尺寸 Dimensions								额定载荷 Load ratings		重量 Weight ≈kg
	mm/inch								动载荷 Dynamic	静载荷 Static	
	d	D	B	C	dk	rs min	r1s min	α° ≈			
GEZ12ES	12.7	22.225	11.1	9.525	18	0.15	0.6	6	13	41	0.022
	0.5	0.875	0.437	0.375	0.709	0.006	0.024				
GEZ15ES	15.875	26.988	13.894	11.913	23	0.15	0.6	6	22	65	0.036
	0.625	1.0625	0.547	0.469	0.906	0.006	0.024				
GEZ19ES	19.05	31.75	16.662	14.275	27.5	0.3	0.6	6	31	95	0.053
	0.75	1.25	0.656	0.562	1.083	0.012	0.024				
GEZ22ES	22.225	36.513	19.431	16.662	32	0.3	0.6	6	42	127	0.085
	0.875	1.4375	0.756	0.656	1.26	0.012	0.024				
GEZ25ES	25.4	41.275	22.225	19.05	36.5	0.3	0.6	6	56	166	0.121
	1	1.625	0.875	0.75	1.437	0.012	0.024				
GEZ31ES	31.75	50.8	27.762	23.8	45.5	0.6	0.6	6	86	260	0.23
	1.25	2	1.093	0.937	1.791	0.024	0.024				
GEZ34ES	34.925	55.563	30.15	26.187	49	0.6	1	5	102	310	0.35
	1.375	2.1875	1.187	1.031	1.929	0.024	0.04				
GEZ38ES	38.1	61.913	33.325	28.575	54.7	0.6	1	6	125	375	0.42
	1.5	2.4375	1.312	1.125	2.154	0.024	0.04				
GEZ44ES	44.45	71.438	38.887	33.325	63.9	0.6	1	6	170	510	0.64
	1.75	2.8125	1.531	1.312	2.516	0.024	0.04				
GEZ50ES	50.8	80.963	44.45	38.1	73	0.6	1	6	224	670	0.93
	2	3.1875	1.75	1.5	2.874	0.024	0.04				
GEZ57ES	57.15	90.488	50.013	42.85	82	0.6	1	6	280	850	1.3
	2.25	3.5625	1.969	1.687	3.228	0.024	0.04				
GEZ63ES	63.5	100.013	55.55	47.625	92	1	1	6	355	1060	1.85
	2.5	3.9375	2.187	1.875	3.622	0.04	0.04				
GEZ69ES	69.85	111.125	61.112	52.375	100	1	1	6	415	1250	2.4
	2.75	4.375	2.406	2.062	3.937	0.04	0.04				
GEZ76ES	76.2	120.65	66.675	57.15	109.5	1	1	6	500	1500	3.1
	3	4.75	2.625	2.25	4.311	0.04	0.04				
GEZ82ES	82.55	130.175	72.238	61.9	119	1	1	6	585	1760	3.8
	3.25	5.125	2.844	2.437	4.685	0.04	0.04				
GEZ88ES	88.9	139.7	77.775	66.675	128	1	1	6	680	2040	4.8
	3.5	5.5	3.062	2.625	5.039	0.04	0.04				
GEZ95ES	95.25	149.225	83.337	71.425	137	1	1	6	780	2360	5.8
	3.75	5.875	3.281	2.812	5.394	0.04	0.04				
GEZ101ES	101.6	158.75	88.9	76.2	146	1	1	6	900	2650	7
	4	6.25	3.5	3	5.748	0.04	0.04				
GEZ107ES	107.95	168.275	94.463	80.95	155	1	1	6	1000	3000	8.4
	4.25	6.625	3.719	3.187	6.102	0.04	0.04				



向心关节轴承 Radial Spherical Plain Bearings



滑动摩擦副：钢 / 钢
Sliding contact surfaces: Steel / Steel

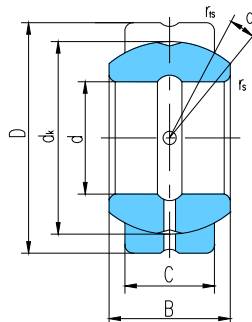

GEZ...ES

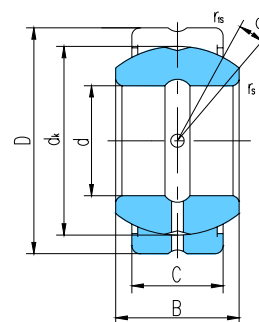

GEZ...ES-2RS

轴承型号 Bearing number		外形尺寸 Dimensions							额定载荷 Load ratings		重量 Weight ≈kg	
		mm/inch							kN			
		d	D	B	C	dk	rs min	rls min	α° ≈	动载荷 Dynamic	静载荷 Static	
GEZ114ES	GEZ114ES-2RS	114.3	177.8	100.013	85.725	164.5	1	1	6	1120	3400	9.8
		4.5	7	3.937	3.375	6.476	0.04	0.04				
GEZ120ES	GEZ120ES-2RS	120.65	187.325	105.562	90.475	173.5	1	1	6	1250	3750	11.5
		4.75	7.375	4.156	3.562	6.831	0.04	0.04				
GEZ127ES	GEZ127ES-2RS	127	196.85	111.125	95.25	183	1	1	6	1400	4150	13.5
		5	7.75	4.375	3.75	7.205	0.04	0.04				
GEZ152ES	GEZ152ES-2RS	152.4	222.25	120.65	104.775	207	1	1	5	1730	5200	17.5
		6	8.75	4.75	4.125	8.15	0.04	0.04				
GEZ165ES	GEZ165ES-2RS	165.1	247.65	123.825	103.175	223	1.1	1.1	7	1830	5500	22.9
		6.5	9.75	4.875	4.062	8.78	0.043	0.043				
GEZ177ES	GEZ177ES-2RS	177.8	266.7	133.35	111.125	240	1.1	1.1	7	2120	6390	28.6
		7	10.5	5.25	4.375	9.449	0.043	0.043				
GEZ190ES	GEZ190ES-2RS	190.5	285.75	142.875	119.05	257	1.1	1.1	7	2440	7340	35.1
		7.5	11.25	5.625	4.687	10.118	0.043	0.043				
GEZ203ES	GEZ203ES-2RS	203.2	304.8	152.4	127	275	1.1	1.1	7	2770	8350	42.6
		8	12	6	5	10.827	0.043	0.043				
GEZ215ES	GEZ215ES-2RS	215.9	323.85	161.925	134.925	292	1.1	1.1	7	3130	9420	51.1
		8.5	12.75	6.375	5.312	11.496	0.043	0.043				
GEZ228ES	GEZ228ES-2RS	228.6	342.9	171.45	142.875	309	1.1	1.1	7	3510	10500	60.7
		9	13.5	6.75	5.625	12.165	0.043	0.043				
GEZ241ES	GEZ241ES-2RS	241.3	361.95	180.975	150.8	326	1.1	1.1	7	3910	11700	71.4
		9.5	14.25	7.125	5.937	12.835	0.043	0.043				
GEZ254ES	GEZ254ES-2RS	254	381	190.5	158.75	343	1.1	1.1	7	4340	13050	83.3
		10	15	7.5	6.25	13.504	0.043	0.043				
GEZ266ES	GEZ266ES-2RS	266.7	400.05	200.025	166.675	360	1.1	1.1	7	4780	14300	96.4
		10.5	15.75	7.875	6.562	14.173	0.043	0.043				
GEZ279ES	GEZ279ES-2RS	279.4	419.1	209.55	174.625	377	1.1	1.1	7	5250	15700	110.8
		11	16.5	8.25	6.875	14.843	0.043	0.043				
GEZ292ES	GEZ292ES-2RS	292.1	438.15	219.075	182.55	395	1.1	1.1	7	5740	17200	126.7
		11.5	17.25	8.625	7.187	15.551	0.043	0.043				
GEZ304ES	GEZ304ES-2RS	304.8	457.2	228.6	190.5	412	1.1	1.1	7	6250	18700	143.9
		12	18	9	7.5	16.22	0.043	0.043				

内径 $d \leq \phi 152.4\text{mm}$ 内圈外球面可设计交叉润滑槽，图示见 P112 图 2，轴承型号需加 “/J”，例如：

GEZ57ES/J

$d \leq \phi 152.4\text{mm}$, the sliding surface of inner ring can be designed crossed grooves, sketch map see page P112 figure2, suffix “/J” is added to bearing number, e.g. GEZ57ES/J



向心关节轴承 Radial Spherical Plain Bearings



滑动摩擦副: 钢 / 钢
Sliding contact surfaces: Steel / Steel

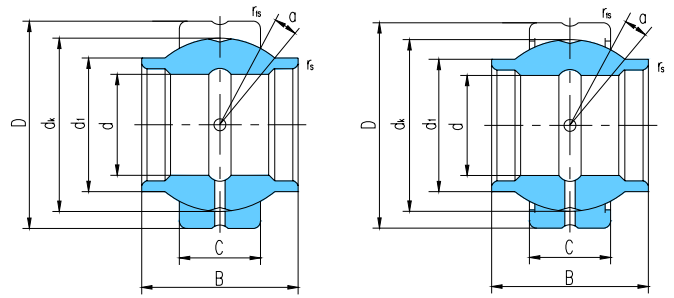

GEWZ...ES

GEWZ...ES-2RS

轴承 型号 Bearing number	外形尺寸 Dimensions									额定载荷 Load ratings		重量 Weight ≈kg
	d	D	B	C	d ₁ max	d _k	r _s min	r _{1s} min	α° ≈	动载荷 Dynamic	静载荷 Static	
GEWZ12ES	12.700	22.225	19.050	9.525	15.875	18	0.15	0.6	5	13	41	0.024
	0.5	0.875	0.75	0.375	0.625	0.709	0.006	0.024				
GEWZ15ES	15.875	26.988	23.800	11.913	19.812	23	0.15	0.6	5	22	65	0.038
	0.625	1.0625	0.937	0.469	0.78	0.906	0.006	0.024				
GEWZ19ES	19.050	31.750	28.575	14.275	23.368	27.5	0.3	0.6	5	31	95	0.064
	0.75	1.25	1.125	0.562	0.92	1.083	0.012	0.024				
GEWZ22ES	22.225	36.513	33.325	16.662	27.178	32	0.3	0.6	5	42	127	0.098
	0.875	1.4375	1.312	0.656	1.07	1.26	0.012	0.024				
GEWZ25ES	25.400	41.275	38.100	19.050	30.988	36.5	0.3	0.6	5	56	166	0.142
	1	1.625	1.5	0.75	1.22	1.437	0.012	0.024				
GEWZ31ES	31.750	50.800	47.625	23.800	38.735	45.5	0.6	0.6	5	86	260	0.271
	1.25	2	1.875	0.937	1.525	1.791	0.024	0.024				
GEWZ34ES	34.925	55.563	52.375	26.187	42.418	49	0.6	1	5	102	310	0.373
	1.375	2.1875	2.062	1.031	1.67	1.929	0.024	0.04				
GEWZ38ES	38.100	61.913	57.150	28.575	46.99	54.7	0.6	1	5	125	375	0.494
	1.5	2.4375	2.25	1.125	1.85	2.154	0.024	0.04				
GEWZ44ES	44.450	71.438	66.675	33.325	54.991	63.9	0.6	1	5	170	510	0.762
	1.75	2.8125	2.625	1.312	2.165	2.516	0.024	0.04				
GEWZ50ES	50.800	80.963	76.200	38.100	62.484	73	0.6	1	5	224	670	1.11
	2	3.1875	3	1.5	2.46	2.874	0.024	0.04				
GEWZ57ES	57.150	90.488	85.725	42.850	70.104	82	0.6	1	5	280	850	1.57
	2.25	3.5625	3.375	1.687	2.76	3.228	0.024	0.04				
GEWZ63ES	63.500	100.013	95.250	47.625	77.724	92	1	1	5	355	1060	2.15
	2.5	3.9375	3.75	1.875	3.06	3.622	0.04	0.04				
GEWZ69ES	69.850	111.125	104.775	52.375	85.852	100	1	1	5	415	1250	2.9
	2.75	4.375	4.125	2.062	3.38	3.937	0.04	0.04				
GEWZ76ES	76.200	120.650	114.300	57.150	93.345	109.5	1	1	5	500	1500	3.59
	3	4.75	4.5	2.25	3.675	4.311	0.04	0.04				
GEWZ82ES	82.550	130.175	123.825	61.900	101.219	119	1	1	5	585	1760	4.69
	3.25	5.125	4.875	2.437	3.985	4.685	0.04	0.04				
GEWZ88ES	88.900	139.700	133.350	66.675	109.22	128	1	1	5	680	2040	5.86
	3.5	5.5	5.25	2.625	4.3	5.039	0.04	0.04				
GEWZ95ES	95.250	149.225	142.875	71.425	116.586	137	1	1	5	780	2360	7.11
	3.75	5.875	5.625	2.812	4.59	5.394	0.04	0.04				
GEWZ101ES	101.600	158.750	152.400	76.200	124.587	146	1	1	5	900	2650	8.56
	4	6.25	6	3	4.905	5.748	0.04	0.04				
GEWZ114ES	114.300	177.800	171.450	85.725	140.335	164.5	1	1	5	1120	3400	12.24
	4.5	7	6.75	3.375	5.525	6.476	0.04	0.04				
GEWZ127ES	127.000	196.850	190.500	95.250	155.705	183	1	1	5	1400	4150	16.63
	5	7.75	7.5	3.75	6.13	7.205	0.04	0.04				
GEWZ152ES	152.400	222.250	209.550	104.775	178.308	207	1	1	5	1730	5200	20.7
	6	8.75	8.25	4.125	7.02	8.15	0.04	0.04				



向心关节轴承 Radial Spherical Plain Bearings



滑动摩擦副：钢 / 钢

Sliding contact surfaces: Steel / Steel

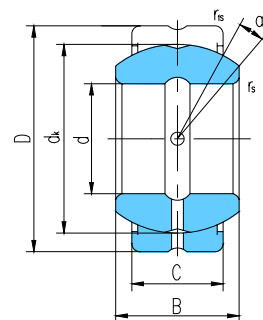
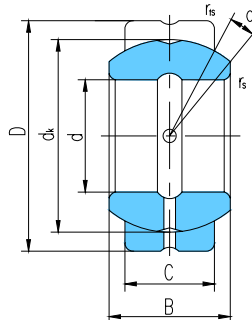

GEGZ...ES

GEGZ...ES-2RS

轴承型号 Bearing number		外形尺寸 Dimensions							额定载荷 Load ratings		重量 Weight ≈kg	
		d	D	B	C	dk	rs min	r1s min	α° ≈	动载荷 Dynamic		静载荷 Static
GEGZ31ES	GEGZ31ES-2RS	31.750	61.913	35.306	28.575	54.7	0.6	1	15	125	375	0.454
		1.25	2.4375	1.39	1.125	2.154	0.024	0.04				
GEGZ38ES	GEGZ38ES-2RS	38.100	71.438	40.132	33.325	63.9	0.6	1	14	170	510	0.726
		1.5	2.8125	1.58	1.312	2.516	0.024	0.04				
GEGZ44ES	GEGZ44ES-2RS	44.450	80.963	46.228	38.100	73	0.6	1	14	224	670	1.14
		1.75	3.1875	1.82	1.5	2.874	0.024	0.04				
GEGZ50ES	GEGZ50ES-2RS	50.800	90.488	52.578	42.850	82	0.6	1	14	280	850	1.68
		2	3.5625	2.07	1.687	3.228	0.024	0.04				
GEGZ57ES	GEGZ57ES-2RS	57.150	100.013	58.877	47.625	92	0.6	1	14	355	1060	2.01
		2.25	3.9375	2.318	1.875	3.622	0.024	0.04				
GEGZ63ES	GEGZ63ES-2RS	63.500	111.125	64.643	52.375	100	1	1	14	415	1250	2.95
		2.5	4.375	2.545	2.062	3.937	0.04	0.04				
GEGZ69ES	GEGZ69ES-2RS	69.850	120.650	70.866	57.150	109.5	1	1	14	500	1500	3.63
		2.75	4.75	2.79	2.25	4.311	0.04	0.04				
GEGZ76ES	GEGZ76ES-2RS	76.200	130.175	76.759	61.900	119	1	1	14	585	1760	4.36
		3	5.125	3.022	2.437	4.685	0.04	0.04				
GEGZ82ES	GEGZ82ES-2RS	82.550	139.700	82.931	66.675	128	1	1	14	680	2040	5.31
		3.25	5.5	3.265	2.625	5.039	0.04	0.04				
GEGZ88ES	GEGZ88ES-2RS	88.900	149.225	90.424	71.425	137	1	1	14	780	2360	6.81
		3.5	5.875	3.56	2.812	5.394	0.04	0.04				
GEGZ95ES	GEGZ95ES-2RS	95.250	158.750	94.945	76.200	146	1	1	14	900	2650	8.85
		3.75	6.25	3.738	3	5.748	0.04	0.04				
GEGZ101ES	GEGZ101ES-2RS	101.600	177.800	107.315	85.725	164.5	1	1	10	1120	3400	10.2
		4	7	4.225	3.375	6.476	0.04	0.04				
GEGZ114ES	GEGZ114ES-2RS	114.300	196.850	119.126	95.250	183	1	1	10	1400	4150	13.6
		4.5	7.75	4.69	3.75	7.205	0.04	0.04				
GEGZ139ES	GEGZ139ES-2RS	139.700	222.250	125.730	104.775	207	1	1	9	1730	5200	20.4
		5.5	8.75	4.95	4.125	8.15	0.04	0.04				



向心关节轴承 Radial Spherical Plain Bearings



滑动摩擦副：钢 / 钢

Sliding contact surfaces: Steel / Steel

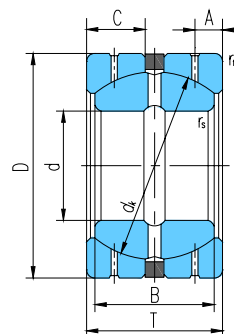

轴承型号 Bearing number	外形尺寸 Dimensions									额定载荷 Load ratings kN		重量 Weight ≈kg
	d	D	B	C	T	A	dk	r _s min	r _{1s} min	动载荷 Dynamic	静载荷 Static	
GEGZ31HS/K	31.750	61.913	35.306	16.764	38.1	7.925	54.7	1	2.5	99	395	0.363
	1.25	2.4375	1.39	0.66	1.5	0.312	2.154	0.04	0.1			
GEGZ38HS/K	38.100	71.438	40.132	20.066	44.704	8.331	63.9	1	2.5	135	540	0.545
	1.5	2.8125	1.58	0.79	1.76	0.328	2.516	0.04	0.1			
GEGZ44HS/K	44.450	80.963	46.228	23.368	51.308	9.525	73	1.5	3.5	180	720	0.976
	1.75	3.1875	1.82	0.92	2.02	0.375	2.874	0.06	0.14			
GEGZ50HS/K	50.800	90.488	52.578	26.67	57.912	11.506	82	1.5	3.5	230	920	1.38
	2	3.5625	2.07	1.05	2.28	0.453	3.228	0.06	0.14			
GEGZ57HS/K	57.150	100.013	58.877	29.972	64.516	12.7	92	1.5	3.5	295	1180	1.90
	2.25	3.9375	2.318	1.18	2.54	0.5	3.622	0.06	0.14			
GEGZ63HS/K	63.500	111.125	64.643	32.385	71.12	13.081	100	2	4.5	345	1380	2.57
	2.5	4.375	2.545	1.275	2.8	0.515	3.937	0.08	0.18			
GEGZ69HS/K	69.850	120.650	70.866	35.687	77.724	14.681	109.5	2	4.5	420	1680	3.43
	2.75	4.75	2.79	1.405	3.06	0.578	4.311	0.08	0.18			
GEGZ76HS/K	76.200	130.175	76.759	39.243	84.836	16.662	119	2	4.5	500	2000	4.41
	3	5.125	3.022	1.545	3.34	0.656	4.685	0.08	0.18			
GEGZ82HS/K	82.550	139.700	82.931	42.545	91.44	17.856	128	2	4.5	585	2340	5.56
	3.25	5.5	3.265	1.675	3.6	0.703	5.039	0.08	0.18			
GEGZ88HS/K	88.900	149.225	90.424	45.847	98.044	19.431	137	2	4.5	675	2700	6.86
	3.5	5.875	3.56	1.805	3.86	0.765	5.394	0.08	0.18			
GEGZ95HS/K	95.250	158.750	94.945	49.149	104.648	19.837	146	2	4.5	775	3100	8.36
	3.75	6.25	3.738	1.935	4.12	0.781	5.748	0.08	0.18			
GEGZ101HS/K	101.600	177.800	107.315	55.753	117.856	22.225	164.5	2	4.5	1000	4000	10
	4	7	4.225	2.195	4.64	0.875	6.476	0.08	0.18			
GEGZ114HS/K	114.300	196.850	119.126	62.357	131.064	25.4	183	2	4.5	1230	4920	14.88
	4.5	7.75	4.69	2.455	5.16	1	7.205	0.08	0.18			
GEGZ139HS/K	139.700	222.250	125.730	66.421	139.192	34.798	207	2	4.5	1480	5920	21.79
	5.5	8.75	4.95	2.615	5.48	1.37	8.15	0.08	0.18			



向心关节轴承 Radial Spherical Plain Bearings



滑动摩擦副：钢 / 钢

Sliding contact surfaces: Steel / Steel

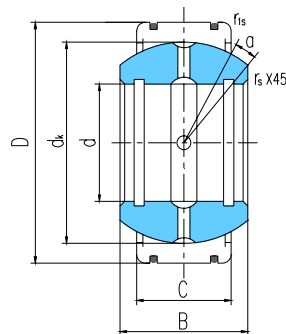

轴承型号 Bearing number	外形尺寸 Dimensions mm								额定载荷 Load ratings kN		重量 Weight ≈ kg
	d	D	B	C	dk	rs min	r1s min	α° ≈	动载荷 Dynamic	静载荷 Static	
GEK25XS-2RS	25	68	40	28	50	0.6	1	19	117	590	0.707
GEK30XS-2RS	30	70	47	32	60	0.6	1	19	163	813	0.814
GEK35XS-2RS	35	80	54	38	70	0.6	1	17	226	1130	1.23
GEK40XS-2RS	40	90	64	44	80	0.6	1	19	298	1490	2
GEK45XS-2RS	45	100	72	52	90	0.6	1	17	398	1990	2.84
GEK50XS-2RS	50	110	80	58	100	1	1	17	493	2450	3.81
GEK55XS-2RS	55	125	90	64	110	1	1	19	598	2990	5.49
GEK60XS-2RS	60	135	98	72	120	1	1	17	732	3660	6.93



向心关节轴承 Radial Spherical Plain Bearings



滑动摩擦副：钢 / 钢

Sliding contact surfaces: Steel / Steel

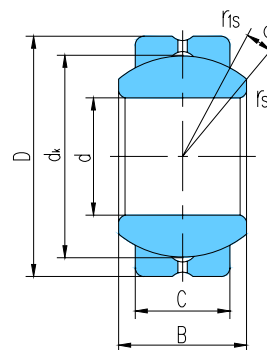

轴承 型号 Bearing number	外形尺寸 Dimensions mm								额定载荷 Load ratings kN		重量 Weight ≈kg
	d	D	B	C	dk	r_s min	r_{1s} min	α° ≈	动载荷 Dynamic	静载荷 Static	
GEBJ5S	5	13	8	6	11.112	0.3	0.3	13	3.2	9	0.006
GEBJ6S	6	16	9	6.75	12.7	0.3	0.3	13	4.1	12	0.010
GEBJ8S	8	19	12	9	15.88	0.3	0.3	13	6.5	20	0.018
GEBJ10S	10	22	14	10.5	19.05	0.3	0.6	13	9.6	28	0.027
GEBJ12S	12	26	16	12	22.23	0.3	0.6	13	12	37	0.043
GEBJ14S	14	28	19	13.5	25.4	0.3	0.6	15	16	49	0.055
GEBJ16S	16	32	21	15	28.58	0.3	0.6	15	20	61	0.081
GEBJ18S	18	35	23	16.5	31.75	0.6	0.6	15	25	74	0.103
GEBJ20S	20	40	25	18	34.93	0.6	0.6	15	30	89	0.149
GEBJ22S	22	42	28	20	38.1	0.6	0.6	15	36	108	0.176
GEBJ25S	25	47	31	22	42.86	0.6	0.6	15	45	130	0.242
GEBJ30S	30	55	37	25	50.8	0.6	0.6	15	61	178	0.378



向心关节轴承

Radial Spherical Plain Bearings



滑动摩擦副：钢 / 钢

Sliding contact surfaces: Steel / Steel

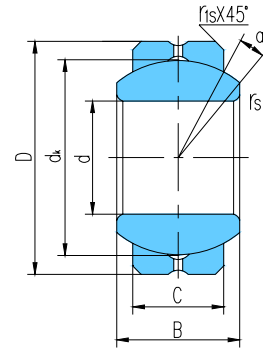

轴承 型号 Bearing number	外形尺寸 Dimensions								额定载荷 Load ratings kN		重量 Weight ≈kg
	d	D	B	C	dk	r _s min	r _s min	α° ≈	动载荷 Dynamic	静载荷 Static	
GEFZ4S	4.83	14.29	7.14	5.54	10.31	0.3	0.38	11	3	15	0.006
	0.19	0.5625	0.281	0.218	0.406	0.012	0.015				
GEFZ6S	6.35	16.67	8.71	6.35	12.70	0.3	0.56	13.5	4.4	22	0.010
	0.25	0.6562	0.343	0.25	0.5	0.012	0.022				
GEFZ7S	7.94	19.05	9.53	7.14	14.27	0.3	0.81	12	6	28	0.014
	0.3125	0.75	0.375	0.281	0.562	0.012	0.032				
GEFZ9S	9.53	20.64	10.31	7.92	16.66	0.3	0.81	10	7.4	37	0.018
	0.375	0.8125	0.406	0.312	0.656	0.012	0.032				
GEFZ11S	11.11	23.02	11.10	8.71	17.45	0.3	0.81	8	8.4	42	0.021
	0.4375	0.9062	0.437	0.343	0.687	0.012	0.032				
GEFZ12S	12.70	25.40	12.70	9.91	20.65	0.3	0.81	9.5	12	58	0.029
	0.5	1	0.5	0.39	0.813	0.012	0.032				
GEFZ14S	14.29	27.78	14.27	11.10	23.01	0.3	0.81	9.5	15	73	0.042
	0.5625	1.0937	0.562	0.437	0.906	0.012	0.032				
GEFZ15S	15.88	30.16	15.88	12.70	25.40	0.3	0.81	9.5	19	94	0.053
	0.625	1.1875	0.625	0.5	1	0.012	0.032				
GEFZ19S	19.05	36.51	19.05	15.06	30.15	0.3	1.12	9	28	141	0.094
	0.75	1.4375	0.75	0.593	1.187	0.012	0.044				
GEFZ22S	22.23	39.69	22.23	17.86	33.32	0.6	1.12	9.5	37	186	0.119
	0.875	1.5625	0.875	0.703	1.312	0.024	0.044				
GEFZ25S	25.40	44.45	25.40	20.24	38.10	0.6	1.12	10	49	245	0.173
	1	1.75	1	0.797	1.5	0.024	0.044				



向心关节轴承 Radial Spherical Plain Bearings



滑动摩擦副：钢 / 青铜

Sliding contact surfaces: Steel / Bronze

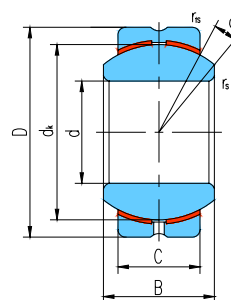

轴承 型号 Bearing number	外形尺寸 Dimensions								额定载荷 Load ratings		重量 Weigh ≈kg
	d	D	B	C	d _k	r _s min	r _{1s} min	α° ≈	动载荷 Dynamic	静载荷 Static	
GEBK5S	5	16	8	6	11.112	0.3	0.3	13	3.3	7.8	0.009
GEBK6S	6	18	9	6.75	12.7	0.3	0.3	13	4.3	9.8	0.013
GEBK8S	8	22	12	9	15.88	0.3	0.3	14	6.8	16	0.024
GEBK10S	10	26	14	10.5	19.05	0.3	0.6	14	10	23	0.039
GEBK12S	12	30	16	12	22.23	0.3	0.6	13	13	31	0.058
GEBK14S	14	34	19	13.5	25.4	0.3	0.6	16	17	40	0.084
GEBK16S	16	38	21	15	28.58	0.3	0.6	15	21	50	0.118
GEBK18S	18	42	23	16.5	31.75	0.6	0.6	15	26	61	0.16
GEBK20S	20	46	25	18	34.93	0.6	0.6	15	31	73	0.21
GEBK22S	22	50	28	20	38.1	0.6	0.6	15	38	88	0.26
GEBK25S	25	56	31	22	42.86	0.6	0.6	15	47	110	0.39
GEBK28S	28	62	35	25	47.63	0.6	0.6	15	59	138	0.50
GEBK30S	30	66	37	25	50.8	0.6	0.6	17	63	148	0.61



向心关节轴承 Radial Spherical Plain Bearings

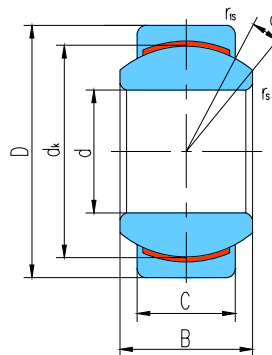

滑动摩擦副：钢 / PTFE 复合材料

Sliding contact surfaces: Steel / PTFE composite material

轴承型号 Bearing number	外形尺寸 Dimensions mm								额定载荷 Load ratings kN		重量 Weight ≈kg
	d	D	B	C	dk	r _s min	r _{1s} min	α° ≈	动载荷 Dynamic	静载荷 Static	
GE4C	4	12	5	3	8	0.3	0.3	16	2.1	5.4	0.003
GE5C	5	14	6	4	10	0.3	0.3	13	3.6	9.1	0.005
GE6C	6	14	6	4	10	0.3	0.3	13	3.6	9.1	0.004
GE8C	8	16	8	5	13	0.3	0.3	15	5.8	14	0.007
GE10C	10	19	9	6	16	0.3	0.3	12	8.6	21	0.011
GE12C	12	22	10	7	18	0.3	0.3	10	11	28	0.017
GE15C	15	26	12	9	22	0.3	0.3	8	18	45	0.026
GE17C	17	30	14	10	25	0.3	0.3	10	22	56	0.040
GE20C	20	35	16	12	29	0.3	0.3	9	31	78	0.064
GE25C	25	42	20	16	35.5	0.6	0.6	7	51	127	0.115
GE30C	30	47	22	18	40.7	0.6	0.6	6	65	166	0.149
GE35C	35	55	25	20	47	0.6	1	6	84	211	0.228
GE40C	40	62	28	22	53	0.6	1	7	104	262	0.318
GE45C	45	68	32	25	60	0.6	1	7	135	337	0.421
GE50C	50	75	35	28	66	0.6	1	6	166	415	0.562
GEG4C	4	14	7	4	10	0.3	0.3	20	3.6	9.1	0.005
GEG5C	5	16	9	5	13	0.3	0.3	21	5.8	14	0.008
GEG6C	6	16	9	5	13	0.3	0.3	21	5.8	14	0.006
GEG8C	8	19	11	6	16	0.3	0.3	21	8.6	21	0.014
GEG10C	10	22	12	7	18	0.3	0.3	18	11	28	0.021
GEG12C	12	26	15	9	22	0.3	0.3	18	18	45	0.033
GEG15C	15	30	16	10	25	0.3	0.3	16	22	56	0.049
GEG17C	17	35	20	12	29	0.3	0.3	19	31	78	0.083
GEG20C	20	42	25	16	35.5	0.3	0.3	17	51	127	0.153
GEG25C	25	47	28	18	40.7	0.6	0.6	17	65	166	0.203
GEG30C	30	55	32	20	47	0.6	0.6	17	84	211	0.304
GEG35C	35	62	35	22	53	0.6	1	16	104	262	0.408
GEG40C	40	68	40	25	60	0.6	1	17	135	337	0.542
GEG45C	45	75	43	28	66	0.6	1	15	166	415	0.713



向心关节轴承 Radial Spherical Plain Bearings

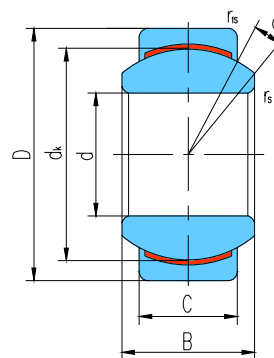

滑动摩擦副：钢 / PTFE 复合材料

Sliding contact surfaces: Steel / PTFE composite material

轴承型号 Bearing number	外形尺寸 Dimensions								额定载荷 Load ratings		重量 Weight ≈kg
	d	D	B	C	dk	r _s min	r _{1s} min	α° ≈	动载荷 Dynamic	静载荷 Static	
GEBJ5C	5	13	8	6	11.112	0.3	0.3	13	6	15	0.006
GEBJ6C	6	16	9	6.75	12.7	0.3	0.3	13	7.7	19	0.010
GEBJ8C	8	19	12	9	15.88	0.3	0.3	13	13	32	0.018
GEBJ10C	10	22	14	10.5	19.05	0.3	0.6	13	18	45	0.027
GEBJ12C	12	26	16	12	22.23	0.3	0.6	13	24	60	0.043
GEBJ14C	14	28	19	13.5	25.4	0.3	0.6	15	31	77	0.055
GEBJ16C	16	32	21	15	28.58	0.3	0.6	15	38	96	0.081
GEBJ18C	18	35	23	16.5	31.75	0.6	0.6	15	47	117	0.103
GEBJ20C	20	40	25	18	34.93	0.6	0.6	15	56	141	0.149
GEBJ22C	22	42	28	20	38.1	0.6	0.6	15	68	171	0.176
GEBJ25C	25	47	31	22	42.86	0.6	0.6	15	84	212	0.242
GEBJ30C	30	55	37	25	50.8	0.6	0.6	15	113	283	0.378



向心关节轴承

Radial Spherical Plain Bearings

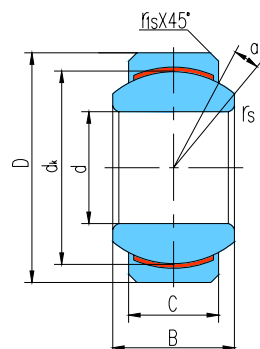

滑动摩擦副：钢 / PTFE 复合材料

Sliding contact surfaces: Steel / PTFE composite material

轴承型号 Bearing number	外形尺寸 Dimensions								额定载荷 Load ratings		重量 Weight ≈kg
	d	D	B	C	dk	rs min	ris min	α° ≈	动载荷 Dynamic	静载荷 Static	
GEFZ4C	4.83	14.29	7.14	5.54	10.31	0.3	0.38	11	5.1	12.8	0.006
	0.19	0.5625	0.281	0.218	0.406	0.012	0.015				
GEFZ6C	6.35	16.67	8.71	6.35	12.70	0.3	0.56	13.5	7.2	18.4	0.010
	0.25	0.6562	0.343	0.25	0.5	0.012	0.022				
GEFZ7C	7.94	19.05	9.53	7.14	14.27	0.3	0.81	12	9.1	22.9	0.014
	0.3125	0.75	0.375	0.281	0.562	0.012	0.032				
GEFZ9C	9.53	20.64	10.31	7.92	16.66	0.3	0.81	10	11.8	29.6	0.018
	0.375	0.8125	0.406	0.312	0.656	0.012	0.032				
GEFZ11C	11.11	23.02	11.10	8.71	17.45	0.3	0.81	8	13.6	34.1	0.021
	0.4375	0.9062	0.437	0.343	0.687	0.012	0.032				
GEFZ12C	12.70	25.40	12.70	9.91	20.65	0.3	0.81	9.5	18.4	46	0.029
	0.5	1	0.5	0.39	0.813	0.012	0.032				
GEFZ14C	14.29	27.78	14.27	11.10	23.01	0.3	0.81	9.5	23	57.4	0.042
	0.5625	1.0937	0.562	0.437	0.906	0.012	0.032				
GEFZ15C	15.88	30.16	15.88	12.70	25.40	0.3	0.81	9.5	29	72.5	0.053
	0.625	1.1875	0.625	0.5	1	0.012	0.032				
GEFZ19C	19.05	36.51	19.05	15.06	30.15	0.3	1.12	9	40.8	102.1	0.094
	0.75	1.4375	0.75	0.593	1.187	0.012	0.044				
GEFZ22C	22.23	39.69	22.23	17.86	33.32	0.6	1.12	9.5	53.5	133.8	0.119
	0.875	1.5625	0.875	0.703	1.312	0.024	0.044				
GEFZ25C	25.40	44.45	25.40	20.24	38.10	0.6	1.12	10	69.4	173.5	0.173
	1	1.75	1	0.797	1.5	0.024	0.044				



向心关节轴承 Radial Spherical Plain Bearings

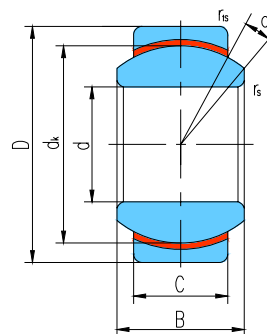

滑动摩擦副：钢 / PTFE 塑料

Sliding contact surfaces: Stainless steel / PTFE plastic

轴承型号 Bearing number	外形尺寸 Dimensions mm								额定载荷 Load ratings kN		重量 Weight ≈ kg
	d	D	B	C	d _k	r _s min	r _{1s} min	α° ≈	动载荷 Dynamic	静载荷 Static	
GE10N	10	19	9	6	16	0.3	0.3	12	5.7	8.6	0.011
GE12N	12	22	10	7	18	0.3	0.3	10	7.5	11	0.017
GE15N	15	26	12	9	22	0.3	0.3	8	11	17	0.026
GE17N	17	30	14	10	25	0.3	0.3	10	15	22	0.040
GE20N	20	35	16	12	29	0.3	0.3	9	20	31	0.064
GE25N	25	42	20	16	35.5	0.6	0.6	7	34	51	0.115
GE30N	30	47	22	18	40.7	0.6	0.6	6	43	65	0.149
GE35N	35	55	25	20	47	0.6	1	6	56	84	0.228
GE40N	40	62	28	22	53	0.6	1	7	69	104	0.318
GE45N	45	68	32	25	60	0.6	1	7	90	135	0.421
GE50N	50	75	35	28	66	0.6	1	6	110	166	0.562
GE60N	60	90	44	36	80	1	1	6	172	259	1.03
GEG8N	8	19	11	6	16	0.3	0.3	21	5.7	8.6	0.014
GEG10N	10	22	12	7	18	0.3	0.3	18	7.5	11	0.021
GEG12N	12	26	15	9	22	0.3	0.3	18	11	17	0.033
GEG15N	15	30	16	10	25	0.3	0.3	16	15	22	0.049
GEG17N	17	35	20	12	29	0.3	0.3	19	20	31	0.083
GEG20N	20	42	25	16	35.5	0.3	0.6	17	34	51	0.153
GEG25N	25	47	28	18	40.7	0.6	0.6	17	43	65	0.203
GEG30N	30	55	32	20	47	0.6	1	17	56	84	0.304
GEG35N	35	62	35	22	53	0.6	1	16	69	104	0.408
GEG40N	40	68	40	25	60	0.6	1	17	90	135	0.542
GEG45N	45	75	43	28	66	0.6	1	15	110	166	0.713
GEG50N	50	90	56	36	80	0.6	1	17	172	259	1.14



向心关节轴承 Radial Spherical Plain Bearings



滑动摩擦副：钢 / PTFE 编织物
Sliding contact surfaces: Steel / PTFE fabric

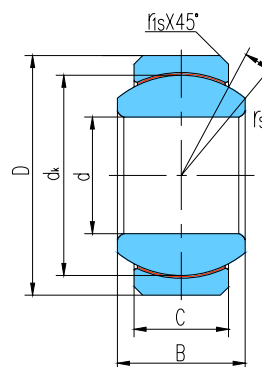

轴承型号 Bearing number	外形尺寸 Dimensions								额定载荷 Load ratings kN		重量 Weight ≈ kg
	d	D	B	C	d _k	r _s min	r _{is} min	α° ≈	动载荷 Dynamic	静载荷 Static	
GEFZ4T	4.83	14.29	7.14	5.54	10.31	0.3	0.38	11	7.4	11	0.006
	0.19	0.5625	0.281	0.218	0.406	0.012	0.015				
GEFZ6T	6.35	16.67	8.71	6.35	12.70	0.3	0.56	13.5	10	15	0.010
	0.25	0.6562	0.343	0.25	0.5	0.012	0.022				
GEFZ7T	7.94	19.05	9.53	7.14	14.27	0.3	0.81	12	13	19	0.014
	0.3125	0.75	0.375	0.281	0.562	0.012	0.032				
GEFZ9T	9.53	20.64	10.31	7.92	16.66	0.3	0.81	10	17	25	0.018
	0.375	0.8125	0.406	0.312	0.656	0.012	0.032				
GEFZ11T	11.11	23.02	11.10	8.71	17.45	0.3	0.81	8	19	28	0.021
	0.4375	0.9062	0.437	0.343	0.687	0.012	0.032				
GEFZ12T	12.70	25.40	12.70	9.91	20.65	0.3	0.81	9.5	26	39	0.029
	0.5	1	0.5	0.39	0.813	0.012	0.032				
GEFZ14T	14.29	27.78	14.27	11.10	23.01	0.3	0.81	9.5	33	49	0.042
	0.5625	1.0937	0.562	0.437	0.906	0.012	0.032				
GEFZ15T	15.88	30.16	15.88	12.70	25.40	0.3	0.81	9.5	41	61	0.053
	0.625	1.1875	0.625	0.5	1	0.012	0.032				
GEFZ19T	19.05	36.51	19.05	15.06	30.15	0.3	1.12	9	59	88	0.094
	0.75	1.4375	0.75	0.593	1.187	0.012	0.044				
GEFZ22T	22.23	39.69	22.23	17.86	33.32	0.6	1.12	9.5	89	133	0.119
	0.875	1.5625	0.875	0.703	1.312	0.024	0.044				
GEFZ25T	25.40	44.45	25.40	20.24	38.10	0.6	1.12	10	115	172	0.173
	1	1.75	1	0.797	1.5	0.024	0.044				



向心关节轴承 Radial Spherical Plain Bearings



滑动摩擦副：钢 / PTFE 复合材料

Sliding contact surfaces: Steel / PTFE composite material

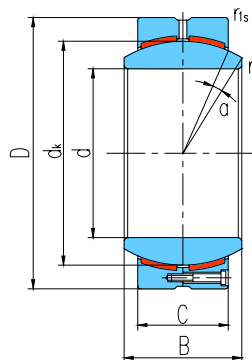

GEH...HC

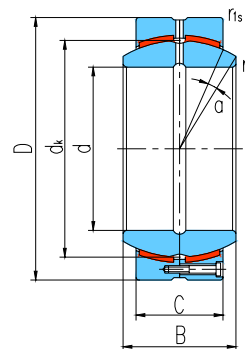

GEH...HCS

轴承型号 Bearing number		外形尺寸 Dimensions								额定载荷 Load ratings		重量 Weight ≈kg
		mm								kN		
		d	D	B	C	dk	rs min	r1s min	α° ≈	动载荷 Dynamic	静载荷 Static	
GEH100HC	GEH100HCS	100	150	71	67	135	1	1	2	900	1800	5.07
GEH110HC	GEH110HCS	110	160	78	74	145	1	1	2	1070	2140	6.21
GEH120HC	GEH120HCS	120	180	85	80	160	1	1	2	1280	2560	8.87
GEH140HC	GEH140HCS	140	210	100	95	185	1	1	2	1750	3500	14.6
GEH160HC	GEH160HCS	160	230	115	109	210	1	1	2	2280	4560	18.6
GEH180HC	GEH180HCS	180	260	128	122	240	1.1	1.1	2	2920	5840	26.7
GEH200HC	GEH200HCS	200	290	140	134	260	1.1	1.1	2	3480	6960	37.1
GEH220HC	GEH220HCS	220	320	155	148	290	1.1	1.1	2	4290	8580	49.4
GEH240HC	GEH240HCS	240	340	170	162	310	1.1	1.1	2	5020	10040	57.9
GEH260HC	GEH260HCS	260	370	185	175	340	1.1	1.1	2	5950	11900	75.2
GEH280HC	GEH280HCS	280	400	200	190	370	1.1	1.1	2	7030	14060	96
GEH300HC	GEH300HCS	300	430	212	200	390	1.1	1.1	2	7800	15600	117
GEH320HC	GEH320HCS	320	460	230	218	414	1.1	3	2	9020	18040	148
GEH340HC	GEH340HCS	340	480	243	230	434	1.1	3	2	9980	19960	163
GEH360HC	GEH360HCS	360	520	258	243	474	1.1	4	2	11510	23020	213
GEH380HC	GEH380HCS	380	540	272	258	494	1.5	4	2	12740	25480	236
GEH400HC	GEH400HCS	400	580	280	265	514	1.5	4	2	13620	27240	290
GEH420HC	GEH420HCS	420	600	300	280	534	1.5	4	2	14950	29900	319
GEH440HC	GEH440HCS	440	630	315	300	574	1.5	4	2	17220	34440	379
GEH460HC	GEH460HCS	460	650	325	308	593	1.5	4	2	18260	36520	404
GEH480HC	GEH480HCS	480	680	340	320	623	2	5	2	19930	39860	463
GEH500HC	GEH500HCS	500	710	355	335	643	2	5	2	21540	43080	529
GEH530HC	GEH530HCS	530	750	375	355	673	2	5	2	23890	47780	620
GEH560HC	GEH560HCS	560	800	400	380	723	2	5	2	27470	54940	770
GEH600HC	GEH600HCS	600	850	425	400	773	2	6	2	30920	61840	903
GEH630HC	GEH630HCS	630	900	450	425	813	3	6	2	34550	69100	1092

可提供滑动摩擦副为钢 / 双金属或钢 / 聚甲醛的向心关节轴承。Can supply other spherical bearings with Sliding contact surfaces Steel / Double metal or Steel / Polyformaldehyde.



向心关节轴承 Radial Spherical Plain Bearings



滑动摩擦副：钢 / PTFE 复合材料

Sliding contact surfaces: Steel / PTFE composite material

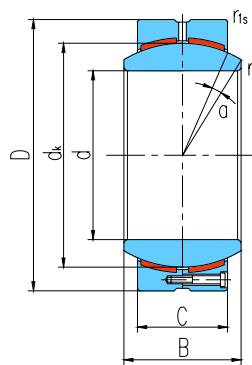

GEC...HC

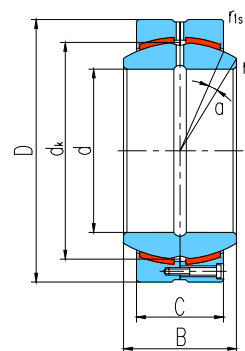

GEC...HCS

轴承型号 Bearing number		外形尺寸 Dimensions							额定载荷 Load ratings		重量 Weight ≈kg	
		mm							kN			
		d	D	B	C	dk	rs min	r1s min	α° ≈	动载荷 Dynamic	静载荷 Static	
GEC320HC	GEC320HCS	320	440	160	135	380	1.1	3	4	5130	10260	78
GEC340HC	GEC340HCS	340	460	160	135	400	1.1	3	3	5400	10800	83
GEC360HC	GEC360HCS	360	480	160	135	420	1.1	3	3	5670	11340	87
GEC380HC	GEC380HCS	380	520	190	160	450	1.5	4	4	7200	14400	129
GEC400HC	GEC400HCS	400	540	190	160	470	1.5	4	3	7520	15040	135
GEC420HC	GEC420HCS	420	560	190	160	490	1.5	4	3	7840	15680	141
GEC440HC	GEC440HCS	440	600	218	185	520	1.5	4	3	9620	19240	196
GEC460HC	GEC460HCS	460	620	218	185	540	1.5	4	3	9990	19980	204
GEC480HC	GEC480HCS	480	650	230	195	565	2	5	3	11000	22000	239
GEC500HC	GEC500HCS	500	670	230	195	585	2	5	3	11400	22800	248
GEC530HC	GEC530HCS	530	710	243	205	620	2	5	3	12710	25420	294
GEC560HC	GEC560HCS	560	750	258	215	655	2	5	4	14080	28160	345
GEC600HC	GEC600HCS	600	800	272	230	700	2	5	3	16100	32200	413

可提供滑动摩擦副为钢 / 双金属或钢 / 聚甲醛的向心关节轴承。Can supply other spherical bearings with Sliding contact surfaces Steel / Double metal or Steel / Polyformaldehyde.



向心关节轴承 Radial Spherical Plain Bearings



滑动摩擦副: 钢 / PTFE 编织物

Sliding contact surfaces: Steel / PTFE fabric

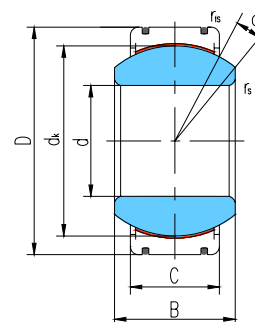
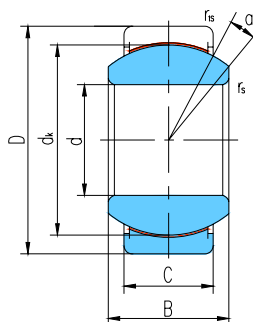

GE...ET-2RS

GE...XT-2RS

轴承 型号 Bearing number	外形尺寸 Dimensions								额定载荷 Load ratings		重量 Weight ≈kg
	mm								kN		
	d	D	B	C	dk	r _s min	r _{1s} min	α° ≈	动载荷 Dynamic	静载荷 Static	
GE15ET-2RS	15	26	12	9	22	0.3	0.3	8	25	59	0.026
GE17ET-2RS	17	30	14	10	25	0.3	0.3	10	32	75	0.040
GE20ET-2RS	20	35	16	12	29	0.3	0.3	9	45	104	0.064
GE25ET-2RS	25	42	20	16	35.5	0.6	0.6	7	85	204	0.115
GE30ET-2RS	30	47	22	18	40.7	0.6	0.6	6	110	263	0.149
GE35ET-2RS	35	55	25	20	47	0.6	1	6	140	338	0.228
GE40ET-2RS	40	62	28	22	53	0.6	1	7	175	419	0.318
GE45ET-2RS	45	68	32	25	60	0.6	1	7	225	540	0.421
GE50ET-2RS	50	75	35	28	66	0.6	1	6	275	665	0.562
GE55ET-2RS	55	85	40	32	74	0.6	1	7	355	852	0.864
GE60ET-2RS	60	90	44	36	80	1	1	6	430	1030	1.03
GE70ET-2RS	70	105	49	40	92	1	1	6	550	1320	1.57
GE80ET-2RS	80	120	55	45	105	1	1	6	705	1700	2.32
GE90ET-2RS	90	130	60	50	115	1	1	5	860	2070	2.79
GE100ET-2RS	100	150	70	55	130	1	1	7	1070	2570	4.44
GE110ET-2RS	110	160	70	55	140	1	1	6	1150	2770	4.83
GE120ET-2RS	120	180	85	70	160	1	1	6	1680	4030	8.11
GE140XT-2RS	140	210	90	70	180	1	1	7	1890	4530	11.2
GE160XT-2RS	160	230	105	80	200	1	1	8	2400	5760	14.1
GE180XT-2RS	180	260	105	80	225	1.1	1.1	6	2700	6480	18.5
GE200XT-2RS	200	290	130	100	250	1.1	1.1	7	3750	9000	28.4
GE220XT-2RS	220	320	135	100	275	1.1	1.1	8	4120	9900	35.7
GE240XT-2RS	240	340	140	100	300	1.1	1.1	8	4500	10800	39.7
GE260XT-2RS	260	370	150	110	325	1.1	1.1	7	5360	12870	51.5
GE280XT-2RS	280	400	155	120	350	1.1	1.1	6	6300	15120	64.9
GE300XT-2RS	300	430	165	120	375	1.1	1.1	7	6750	16200	77.6



向心关节轴承 Radial Spherical Plain Bearings



滑动摩擦副：钢 / PTFE 编织物
Sliding contact surfaces: Steel / PTFE fabric

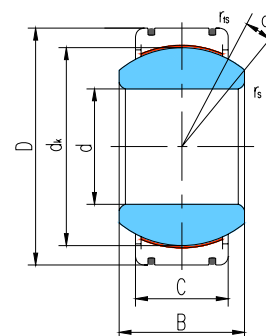
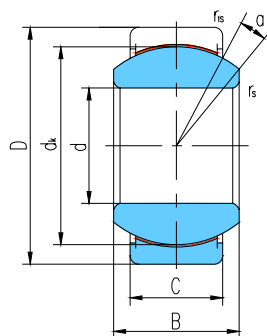

GEG...ET-2RS

GEG...XT-2RS

轴承 型号 Bearing number	外形尺寸 Dimensions								额定载荷 Load ratings		重量 Weight ≈kg
	mm								kN		
	d	D	B	C	dk	rs min	ris min	α° ≈	动载荷 Dynamic	静载荷 Static	
GEG15ET-2RS	15	30	16	10	25	0.3	0.3	16	32	75	0.048
GEG17ET-2RS	17	35	20	12	29	0.3	0.3	19	45	104	0.080
GEG20ET-2RS	20	42	25	16	35.5	0.3	0.6	17	85	204	0.152
GEG25ET-2RS	25	47	28	18	40.7	0.6	0.6	17	110	263	0.199
GEG30ET-2RS	30	55	32	20	47	0.6	1	17	140	338	0.296
GEG35ET-2RS	35	62	35	22	53	0.6	1	16	175	419	0.402
GEG40ET-2RS	40	68	40	25	60	0.6	1	17	225	540	0.535
GEG45ET-2RS	45	75	43	28	66	0.6	1	15	275	665	0.698
GEG50ET-2RS	50	90	56	36	80	0.6	1	17	430	1030	1.42
GEG60ET-2RS	60	105	63	40	92	1	1	17	550	1320	2.09
GEG70ET-2RS	70	120	70	45	105	1	1	16	705	1700	3.01
GEG80ET-2RS	80	130	75	50	115	1	1	14	860	2070	3.61
GEG90ET-2RS	90	150	85	55	130	1	1	15	1070	2570	5.50
GEG100ET-2RS	100	160	85	55	140	1	1	14	1150	2770	6.04
GEG110ET-2RS	110	180	100	70	160	1	1	12	1680	4030	9.74
GEG120XT-2RS	120	210	115	70	180	1	1	16	1890	4530	15.1
GEG140XT-2RS	140	230	130	80	200	1	1	16	2400	5760	18.9
GEG160XT-2RS	160	260	135	80	225	1.1	1.1	16	2700	6480	24.8
GEG180XT-2RS	180	290	155	100	250	1.1	1.1	14	3750	9000	35.9
GEG200XT-2RS	200	320	165	100	275	1.1	1.1	15	4120	9900	44.9
GEG220XT-2RS	220	340	175	100	300	1.1	1.1	16	4500	10800	50.9
GEG240XT-2RS	240	370	190	110	325	1.1	1.1	15	5360	12870	65.3
GEG260XT-2RS	260	400	205	120	350	1.1	1.1	15	6300	15120	82.0
GEG280XT-2RS	280	430	210	120	375	1.1	1.1	15	6750	16200	96.6



向心关节轴承 Radial Spherical Plain Bearings



滑动摩擦副: 不锈钢 / PTFE 编织物

Sliding contact surfaces: Stainless steel / PTFE fabric

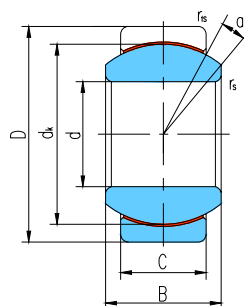

GE...ET/X

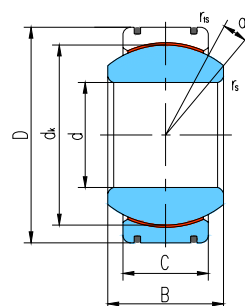

GE...XT/X

轴承 型号 Bearing number	外形尺寸 Dimensions								额定载荷 Load ratings		重量 Weight ≈ kg
	d	D	B	C	dk	r _s min	r _{1s} min	α° ≈	动载荷 Dynamic	静载荷 Static	
GE15ET/X	15	26	12	9	22	0.3	0.3	8	25	59	0.026
GE17ET/X	17	30	14	10	25	0.3	0.3	10	32	75	0.040
GE20ET/X	20	35	16	12	29	0.3	0.3	9	45	104	0.064
GE25ET/X	25	42	20	16	35.5	0.6	0.6	7	85	204	0.115
GE30ET/X	30	47	22	18	40.7	0.6	0.6	6	110	263	0.149
GE35ET/X	35	55	25	20	47	0.6	1	6	140	338	0.228
GE40ET/X	40	62	28	22	53	0.6	1	7	175	419	0.318
GE45ET/X	45	68	32	25	60	0.6	1	7	225	540	0.421
GE50ET/X	50	75	35	28	66	0.6	1	6	275	665	0.562
GE55ET/X	55	85	40	32	74	0.6	1	7	355	852	0.864
GE60ET/X	60	90	44	36	80	1	1	6	430	1030	1.03
GE70XT/X	70	105	49	40	92	1	1	6	550	1320	1.57
GE80XT/X	80	120	55	45	105	1	1	6	705	1700	2.32
GE90XT/X	90	130	60	50	115	1	1	5	860	2070	2.79
GE100XT/X	100	150	70	55	130	1	1	7	1070	2570	4.44
GE110XT/X	110	160	70	55	140	1	1	6	1150	2770	4.83
GE120XT/X	120	180	85	70	160	1	1	6	1680	4030	8.11
GE140XT/X	140	210	90	70	180	1	1	7	1890	4530	11.2
GE160XT/X	160	230	105	80	200	1	1	8	2400	5760	14.1
GE180XT/X	180	260	105	80	225	1.1	1.1	6	2700	6480	18.5
GE200XT/X	200	290	130	100	250	1.1	1.1	7	3750	9000	28.4
GE220XT/X	220	320	135	100	275	1.1	1.1	8	4120	9900	35.7
GE240XT/X	240	340	140	100	300	1.1	1.1	8	4500	10800	39.7
GE260XT/X	260	370	150	110	325	1.1	1.1	7	5360	12870	51.5
GE280XT/X	280	400	155	120	350	1.1	1.1	6	6300	15120	64.9
GE300XT/X	300	430	165	120	375	1.1	1.1	7	6750	16200	77.6

可提供带密封圈的向心关节轴承。 Can supply spherical plain bearing with two seals.



向心关节轴承 Radial Spherical Plain Bearings

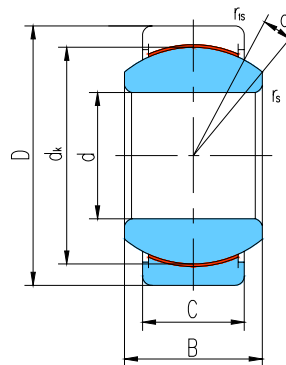

滑动摩擦副：钢 / PTFE 编织物

Sliding contact surfaces: Steel / PTFE fabric

轴承型号 Bearing number	外形尺寸 Dimensions								额定载荷 Load ratings		重量 Weight ≈kg
	mm/inch								动载荷 Dynamic	静载荷 Static	
	d	D	B	C	dk	r _s min	r _{is} min	α° ≈			
GEZ19ET-2RS	19.05	31.75	16.662	14.275	27.5	0.3	0.6	6	50	117	0.053
	0.75	1.25	0.656	0.562	1.081	0.012	0.024				
GEZ22ET-2RS	22.225	36.513	19.431	16.662	32	0.3	0.6	6	69	160	0.085
	0.875	1.4375	0.756	0.656	1.258	0.012	0.024				
GEZ25ET-2RS	25.4	41.275	22.225	19.05	36.5	0.3	0.6	6	104	250	0.121
	1	1.625	0.875	0.75	1.437	0.012	0.024				
GEZ31ET-2RS	31.75	50.8	27.762	23.8	45.5	0.6	0.6	6	160	390	0.23
	1.25	2	1.093	0.937	1.788	0.024	0.024				
GEZ34ET-2RS	34.925	55.563	30.15	26.187	49	0.6	1	5	190	460	0.35
	1.375	2.1875	1.187	1.031	1.926	0.024	0.04				
GEZ38ET-2RS	38.1	61.913	33.325	28.575	54.7	0.6	1	6	235	560	0.42
	1.5	2.4375	1.312	1.125	2.154	0.024	0.04				
GEZ44ET-2RS	44.45	71.438	38.887	33.325	63.9	0.6	1	6	320	765	0.64
	1.75	2.8125	1.531	1.312	2.511	0.024	0.04				
GEZ50ET-2RS	50.8	80.963	44.45	38.1	73	0.6	1	6	415	1000	0.93
	2	3.1875	1.75	1.5	2.869	0.024	0.04				
GEZ57ET-2RS	57.15	90.488	50.013	42.85	82	0.6	1	6	525	1260	1.3
	2.25	3.5625	1.969	1.687	3.223	0.024	0.04				
GEZ63ET-2RS	63.5	100.013	55.55	47.625	92	1	1	6	655	1570	1.85
	2.5	3.9375	2.187	1.875	3.616	0.04	0.04				
GEZ69ET-2RS	69.85	111.125	61.112	52.375	100	1	1	6	785	1880	2.4
	2.75	4.375	2.406	2.062	3.937	0.04	0.04				
GEZ76ET-2RS	76.2	120.65	66.675	57.15	109.5	1	1	6	935	2250	3.1
	3	4.75	2.625	2.25	4.303	0.04	0.04				
GEZ82ET-2RS	82.55	130.175	72.238	61.9	119	1	1	6	1100	2650	3.8
	3.25	5.125	2.844	2.437	4.685	0.04	0.04				
GEZ88ET-2RS	88.9	139.7	77.775	66.675	128	1	1	6	1280	3070	4.8
	3.5	5.5	3.062	2.625	5.04	0.04	0.04				
GEZ95ET-2RS	95.25	149.225	83.337	71.425	137	1	1	6	1460	3520	5.8
	3.75	5.875	3.281	2.812	5.393	0.04	0.04				
GEZ101ET-2RS	101.6	158.75	88.9	76.2	146	1	1	6	1660	4000	7
	4	6.25	3.5	3	5.748	0.04	0.04				
GEZ107ET-2RS	107.95	168.275	94.463	80.95	155	1	1	6	1880	4510	8.4
	4.25	6.625	3.719	3.187	6.102	0.04	0.04				
GEZ114ET-2RS	114.3	177.8	100.013	85.725	164.5	1	1	6	2110	5070	9.8
	4.5	7	3.937	3.375	6.476	0.04	0.04				
GEZ120ET-2RS	120.65	187.325	105.562	90.475	173.5	1	1	6	2350	5650	11.5
	4.75	7.375	4.156	3.562	6.83	0.04	0.04				
GEZ127ET-2RS	127	196.85	111.125	95.25	183	1	1	6	2610	6270	13.5
	5	7.75	4.375	3.75	7.204	0.04	0.04				
GEZ152ET-2RS	152.4	222.25	120.65	104.775	207	1	1	5	3250	7800	17.5
	6	8.75	4.75	4.125	8.15	0.04	0.04				



向心关节轴承 Radial Spherical Plain Bearings

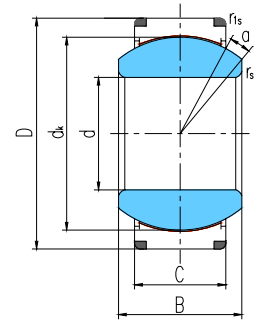
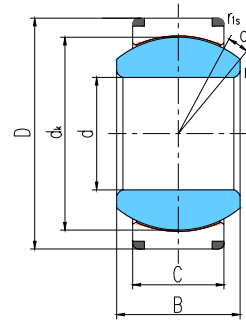
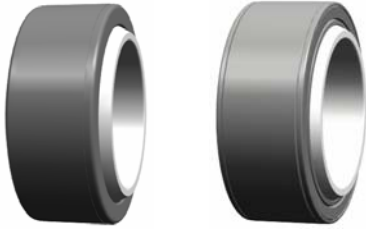

滑动摩擦副：钢 / PTFE 编织物

Sliding contact surfaces: Steel / PTFE fabric

GEC(H)···XT

GEC(H)···XT-2RS

轴承型号 Bearing number		外形尺寸 Dimensions mm								额定载荷 Load ratings kN		重量 Weight ≈ kg
		d	D	B	C	dk	rs min	rls min	α° ≈	动载荷 Dynamic	静载荷 Static	
GEC320XT	GEC320XT-2RS	320	440	160	135	380	1.1	3	4	9230	18460	78
GEC340XT	GEC340XT-2RS	340	460	160	135	400	1.1	3	3	9720	19440	83
GEC360XT	GEC360XT-2RS	360	480	160	135	420	1.1	3	3	10200	20400	87
GEC380XT	GEC380XT-2RS	380	520	190	160	450	1.5	4	4	12960	25920	129
GEC400XT	GEC400XT-2RS	400	540	190	160	470	1.5	4	3	13530	27060	135
GEC420XT	GEC420XT-2RS	420	560	190	160	490	1.5	4	3	14110	28220	141
GEC440XT	GEC440XT-2RS	440	600	218	185	520	1.5	4	3	17310	34620	196
GEC460XT	GEC460XT-2RS	460	620	218	185	540	1.5	4	3	17980	35960	204
GEH100XT	GEH100XT-2RS	100	150	71	67	135	1	1	2	1350	3250	5.07
GEH110XT	GEH110XT-2RS	110	160	78	74	145	1	1	2	1600	3860	6.21
GEH120XT	GEH120XT-2RS	120	180	85	80	160	1	1	2	1920	4600	8.87
GEH140XT	GEH140XT-2RS	140	210	100	95	185	1	1	2	2630	6320	14.6
GEH160XT	GEH160XT-2RS	160	230	115	109	210	1	1	2	3430	8240	18.6
GEH180XT	GEH180XT-2RS	180	260	128	122	240	1.1	1.1	2	4390	10540	26.7
GEH200XT	GEH200XT-2RS	200	290	140	134	260	1.1	1.1	2	5220	12540	37.1
GEH220XT	GEH220XT-2RS	220	320	155	148	290	1.1	1.1	2	6430	15450	49.4
GEH240XT	GEH240XT-2RS	240	340	170	162	310	1.1	1.1	2	7530	18070	57.9
GEH260XT	GEH260XT-2RS	260	370	185	175	340	1.1	1.1	2	8920	21420	75.2
GEH280XT	GEH280XT-2RS	280	400	200	190	370	1.1	1.1	2	10540	25300	96
GEH300XT	GEH300XT-2RS	300	430	212	200	390	1.1	1.1	2	11700	28080	117
GEH320XT	GEH320XT-2RS	320	460	230	218	414	1.1	3	2	16240	32480	148
GEH340XT	GEH340XT-2RS	340	480	243	230	434	1.1	3	2	17960	35920	163
GEH360XT	GEH360XT-2RS	360	520	258	243	474	1.1	4	2	20730	41460	213
GEH380XT	GEH380XT-2RS	380	540	272	258	494	1.5	4	2	22940	45880	236
GEH400XT	GEH400XT-2RS	400	580	280	265	514	1.5	4	2	24510	49020	290
GEH420XT	GEH420XT-2RS	420	600	300	280	534	1.5	4	2	26910	53920	319



向心关节轴承 Radial Spherical Plain Bearings

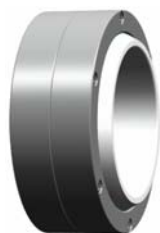

滑动摩擦副：钢 / PTFE 编织物

Sliding contact surfaces: Steel / PTFE fabric

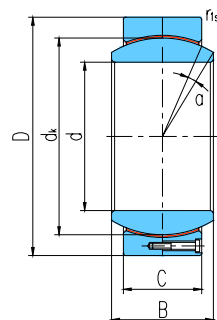

轴承型号 Bearing number	外形尺寸 Dimensions								额定载荷 Load ratings		重量 Weight ≈kg
	d	D	B	C	dk	r _s min	r _{1s} min	α° ≈	动载荷 Dynamic	静载荷 Static	
GEC320HT	320	440	160	135	380	1.1	3	4	9230	18460	78
GEC340HT	340	460	160	135	400	1.1	3	3	9720	19440	83
GEC360HT	360	480	160	135	420	1.1	3	3	10200	20400	87
GEC380HT	380	520	190	160	450	1.5	4	4	12960	25920	129
GEC400HT	400	540	190	160	470	1.5	4	3	13530	27060	135
GEC420HT	420	560	190	160	490	1.5	4	3	14110	28220	141
GEC440HT	440	600	218	185	520	1.5	4	3	17310	34620	196
GEC460HT	460	620	218	185	540	1.5	4	3	17980	35960	204
GEC480HT	480	650	230	195	565	2	5	3	19830	39660	239
GEC500HT	500	670	230	195	585	2	5	3	20530	41060	248
GEC530HT	530	710	243	205	620	2	5	3	22870	45740	294
GEC560HT	560	750	258	215	655	2	5	4	25340	50680	345
GEC600HT	600	800	272	230	700	2	5	3	28980	57960	413



向心关节轴承 Radial Spherical Plain Bearings

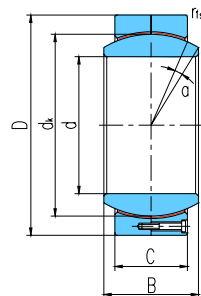

滑动摩擦副：钢 / PTFE 编织物
Sliding contact surfaces: Steel / PTFE fabric

轴承型号 Bearing number	外形尺寸 Dimensions								额定载荷 Load ratings		重量 Weight ≈kg
	d	D	B	C	dk	rs min	r1s min	α° ≈	动载荷 Dynamic	静载荷 Static	
GEH100HT	100	150	71	67	135	1	1	2	1350	3250	5.07
GEH110HT	110	160	78	74	145	1	1	2	1600	3860	6.21
GEH120HT	120	180	85	80	160	1	1	2	1920	4600	8.87
GEH140HT	140	210	100	95	185	1	1	2	2630	6320	14.6
GEH160HT	160	230	115	109	210	1	1	2	3430	8240	18.6
GEH180HT	180	260	128	122	240	1.1	1.1	2	4390	10540	26.7
GEH200HT	200	290	140	134	260	1.1	1.1	2	5220	12540	37.1
GEH220HT	220	320	155	148	290	1.1	1.1	2	6430	15450	49.4
GEH240HT	240	340	170	162	310	1.1	1.1	2	7530	18070	57.9
GEH260HT	260	370	185	175	340	1.1	1.1	2	8920	21420	75.2
GEH280HT	280	400	200	190	370	1.1	1.1	2	10540	25300	96
GEH300HT	300	430	212	200	390	1.1	1.1	2	11700	28080	117
GEH320HT	320	460	230	218	414	1.1	3	2	16240	32480	148
GEH340HT	340	480	243	230	434	1.1	3	2	17960	35920	163
GEH360HT	360	520	258	243	474	1.1	4	2	20730	41460	213
GEH380HT	380	540	272	258	494	1.5	4	2	22940	45880	236
GEH400HT	400	580	280	265	514	1.5	4	2	24510	49020	290
GEH420HT	420	600	300	280	534	1.5	4	2	26910	53920	319
GEH440HT	440	630	315	300	574	1.5	4	2	30990	61980	379
GEH460HT	460	650	325	308	593	1.5	4	2	32870	65740	404
GEH480HT	480	680	340	320	623	2	5	2	35880	71760	463
GEH500HT	500	710	355	335	643	2	5	2	38770	77540	529
GEH530HT	530	750	375	355	673	2	5	2	43000	86000	620
GEH560HT	560	800	400	380	723	2	5	2	49450	98900	770
GEH600HT	600	850	425	400	773	2	6	2	55650	111300	903
GEH630HT	630	900	450	425	813	3	6	2	62190	124380	1092
GEH670HT	670	950	475	450	862	3	6	2	69820	139640	1270
GEH710HT	710	1000	500	475	912	3	6	2	77970	155940	1465
GEH750HT	750	1060	530	500	972	3	6	2	87480	174960	1750
GEH800HT	800	1120	565	530	1022	3	6	2	97490	194980	2029



向心关节轴承 Radial Spherical Plain Bearings

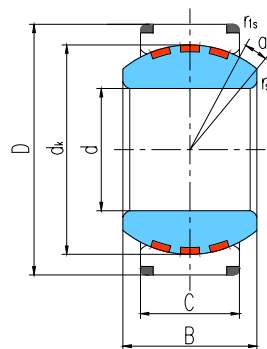

滑动摩擦副：钢 / 铜合金

Sliding contact surfaces: Steel / Copper alloy

轴承 型号 Bearing number	外形尺寸 Dimensions								额定载荷 Load ratings kN		重量 Weight ≈kg
	d	D	B	C	d _k	r _s min	r _{1s} min	α° ≈	动载荷 Dynamic	静载荷 Static	
GE100XF/Q	100	150	70	55	130	1	1	7	710	1420	4.24
GE110XF/Q	110	160	70	55	140	1	1	6	770	1540	4.55
GE120XF/Q	120	180	85	70	160	1	1	6	1120	2240	7.77
GE140XF/Q	140	210	90	70	180	1	1	7	1260	2520	10.7
GE160XF/Q	160	230	105	80	200	1	1	8	1600	3200	13.5
GE180XF/Q	180	260	105	80	225	1.1	1.1	6	1800	3600	17.9
GE200XF/Q	200	290	130	100	250	1.1	1.1	7	2500	5000	27.3
GE220XF/Q	220	320	135	100	275	1.1	1.1	8	2750	5500	34.5
GE240XF/Q	240	340	140	100	300	1.1	1.1	8	3000	6000	38.3
GE260XF/Q	260	370	150	110	325	1.1	1.1	7	3570	7140	49.7
GE280XF/Q	280	400	155	120	350	1.1	1.1	6	4200	8400	63
GE300XF/Q	300	430	165	120	375	1.1	1.1	7	4500	9000	75.3
GEC320XF/Q	320	440	160	135	380	1.1	3	4	5130	10260	75.8
GEC340XF/Q	340	460	160	135	400	1.1	3	3	5400	10800	80.8
GEC360XF/Q	360	480	160	135	420	1.1	3	3	5670	11340	84.5
GEC380XF/Q	380	520	190	160	450	1.5	4	4	7200	14400	125
GEC400XF/Q	400	540	190	160	470	1.5	4	3	7520	15040	131
GEC420XF/Q	420	560	190	160	490	1.5	4	3	7840	15680	137
GEC440XF/Q	440	600	218	185	520	1.5	4	3	9620	19240	191
GEC460XF/Q	460	620	218	185	540	1.5	4	3	9990	19980	199



向心关节轴承 Radial Spherical Plain Bearings



滑动摩擦副：钢 / 铜合金

Sliding contact surfaces: Steel / Copper alloy

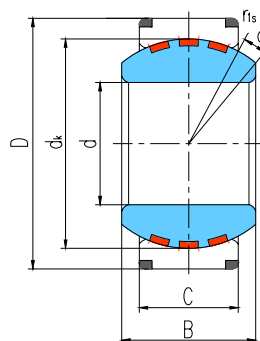

轴承 型号 Bearing number	外形尺寸 Dimensions mm								额定载荷 Load ratings kN		重量 Weight ≈kg
	d	D	B	C	dk	rs min	rls min	α° ≈	动载荷 Dynamic	静载荷 Static	
GEH100XF/Q	100	150	71	67	135	1	1	2	900	1800	4.85
GEH110XF/Q	110	160	78	74	145	1	1	2	1070	2140	5.9
GEH120XF/Q	120	180	85	80	160	1	1	2	1280	2560	8.49
GEH140XF/Q	140	210	100	95	185	1	1	2	1750	3500	14.1
GEH160XF/Q	160	230	115	109	210	1	1	2	2280	4560	17.9
GEH180XF/Q	180	260	128	122	240	1.1	1.1	2	2920	5840	25.9
GEH200XF/Q	200	290	140	134	260	1.1	1.1	2	3480	6960	35.9
GEH220XF/Q	220	320	155	148	290	1.1	1.1	2	4290	8580	48
GEH240XF/Q	240	340	170	162	310	1.1	1.1	2	5020	10040	56
GEH260XF/Q	260	370	185	175	340	1.1	1.1	2	5950	11900	72.8
GEH280XF/Q	280	400	200	190	370	1.1	1.1	2	7030	14060	93.3
GEH300XF/Q	300	430	212	200	390	1.1	1.1	2	7800	15600	114
GEH320XF/Q	320	460	230	218	414	1.1	3	2	9020	18040	144
GEH340XF/Q	340	480	243	230	434	1.1	3	2	9980	19960	158
GEH360XF/Q	360	520	258	243	474	1.1	4	2	11510	23020	207
GEH380XF/Q	380	540	272	258	494	1.5	4	2	12740	25480	230
GEH400XF/Q	400	580	280	265	514	1.5	4	2	13620	27240	283
GEH420XF/Q	420	600	300	280	534	1.5	4	2	14950	29900	312



向心关节轴承 Radial Spherical Plain Bearings



滑动摩擦副：钢 / 铜合金

Sliding contact surfaces: Steel / Copper alloy

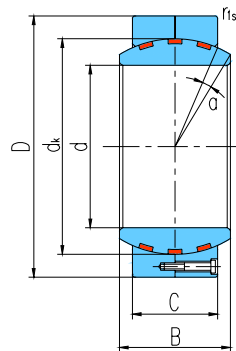

轴承 型号 Bearing number	外形尺寸 Dimensions mm								额定载荷 Load ratings kN		重量 Weight ≈kg
	d	D	B	C	dk	r_s min	r_{1s} min	α° ≈	动载荷 Dynamic	静载荷 Static	
GEH440HF/Q	440	630	315	300	574	1.5	4	2	17220	34440	370
GEH460HF/Q	460	650	325	308	593	1.5	4	2	18260	36520	395
GEH480HF/Q	480	680	340	320	623	2	5	2	19930	39860	453
GEH500HF/Q	500	710	355	335	643	2	5	2	21540	43080	519
GEH530HF/Q	530	750	375	355	673	2	5	2	23890	47780	609
GEH560HF/Q	560	800	400	380	723	2	5	2	27470	54940	754
GEH600HF/Q	600	850	425	400	773	2	6	2	30920	61840	885
GEH630HF/Q	630	900	450	425	813	3	6	2	34550	69100	1072
GEH670HF/Q	670	950	475	450	862	3	6	2	38790	77580	1248
GEH710HF/Q	710	1000	500	475	912	3	6	2	43320	86640	1440
GEH750HF/Q	750	1060	530	500	972	3	6	2	48600	97200	1722
GEH800HF/Q	800	1120	565	530	1022	3	6	2	54160	108320	1998